

Crowtail Start Kit for micro:bit User Guide

The BBC micro:bit is a pocket-sized computer that can easily realize your creativity without much electrical and coding knowledge. There are numerous possibility of creation you can dig out by micro:bit, from robots to musical instruments. However if you want to create more things, just 1 micro:bit is barely not enough, That' s why we introduce the Crowtail Start Kit for micro:bit to you.

The crowtail start kit for micro:bit can make you do a lot of interesting things and brings endless possibilities to your micro:bit. The core board in this kit is Crowtail- Base shield for micro:bit,with which you can use plenty of crowtail sensors.All of that you need to know about Crowtail, there is no need any soldering or jump wire. We have prepared 17 species basic crowtail modules that let you get started with micro:bit. And we also write 20 lessons to teach you use the micro:bit with the sensors step by step. Now, let us enjoy them.



Contents

Lesson 1,How to use button control LED.....	3
Lesson2, Brightness Measurement.....	4
Lesson3, Make a Beeping Noise.....	5
Lesson4. Motor Control.....	6
Lesson5.Motion Detection.....	6
Lesson6. Relay ON/OFF.....	7
Lesson7.Soil Moisture Detection.....	8
Lesson8.Sound Detection.....	9
Lesson9.Breathing LED.....	10
Lesson10.Servo Calibrator.....	11
Lesson11.Magnetic Field Detection.....	12
Lesson12.Control the MOSFET as a Switch.....	13
Lesson13.Obstacle Detection.....	14
Lesson14. IR Distance Measurement.....	15
Lesson15.Use Microwave Detect Movement.....	16
Lesson16.Stairs Lights.....	17
Lesson17.Alarm Clock.....	18
Lesson18.Anti-theft Device.....	19
Lesson19.Mini Fan.....	20
Lesson20.Automatic Watering.....	21



Lesson 1, How to use button control LED

This is a easy experiment, everyone will easy handle it. Connect Crowtail- LED to the P2 interface, upload the bellow code to micro:bit, then click the button A on the micro:bit, the LED will light.

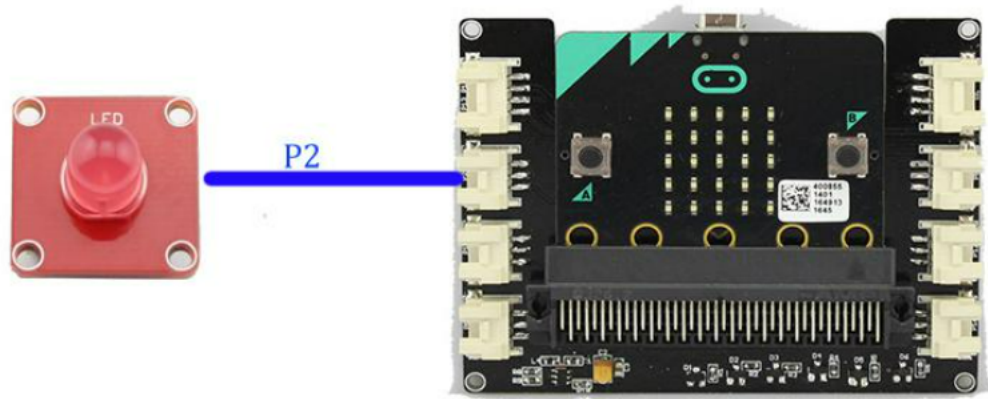

Material:

Micro:bit	x1
Crowtail- Base Shield for Micro:bit	x1
Crowtail- LED	x1

Software:

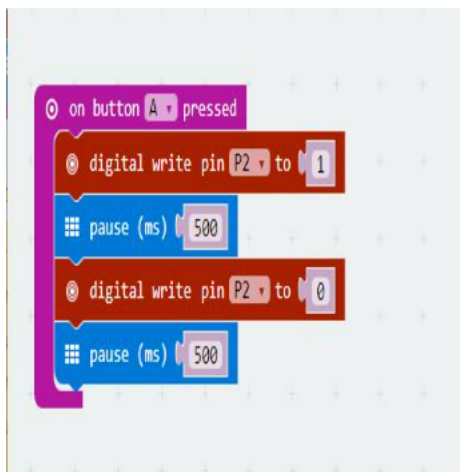

```
input.onButtonPressed(Button.A, () => {  
    pins.digitalWritePin(DigitalPin.P2, 1)  
    basic.pause(500)  
    pins.digitalWritePin(DigitalPin.P2, 0)  
    basic.pause(500)  
})
```

Lesson2, Brightness Measurement

Our eyes can sense the brightness of the light, but it not a accurate value, just a sense, now let us begin to measure the brightness. Please connect Crowtail- Light sensor to P2 interface, upload the bellow code to micro:bit. You will see the brightness value on the LED dot matrix.

Elecrow on-line store, make your making easier.

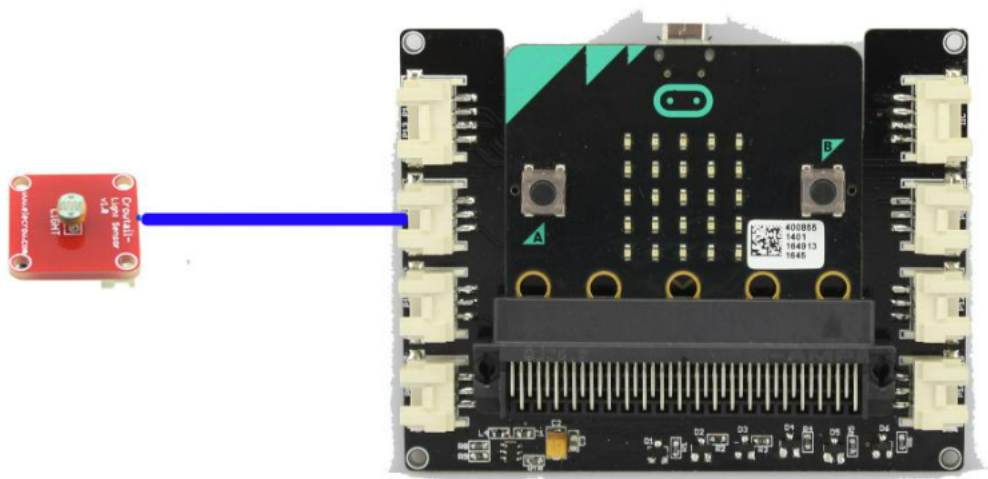

Material:

Micro:bit x1
Crowtail- Base Shield for Micro:bit x1
Crowtail- Light Sensor x1

Software:

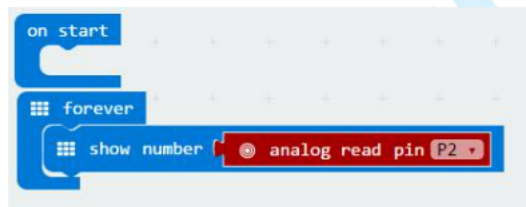

```
basic.forever(() => {  
  
  basic.showNumber(pins.analogReadPin(AnalogPin.P2)  
  )  
})
```

Lesson3, Make a Beeping Noise

This Lesson teach you how to use a buzzer with Micro:bit, Connect the Crowtail- Buzzer to P1 interface, after you upload the code into the micro:bit, you will hear a beeping noise, and you can adjust the delay time to control the beeping frequency.

Elecrow on-line store, make your making easier.

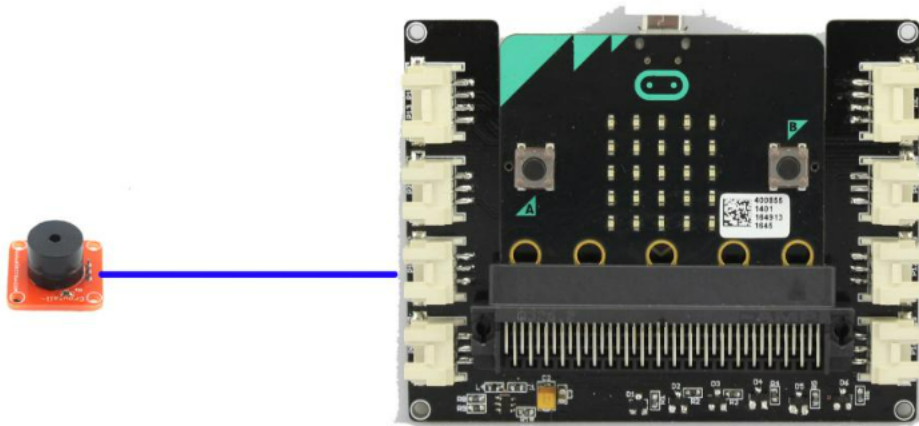

Material:

- Micro:bit x1
- Crowtail- Base Shield for Micro:bit x1
- Crowtail- Buzzer x1

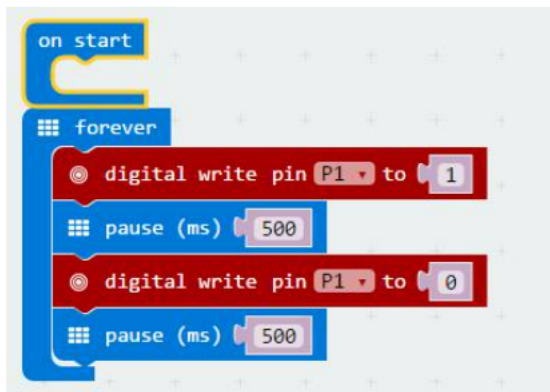

```
basic.forever(() => {
  pins.digitalWritePin(DigitalPin.P1,
  1)
  basic.pause(500)
  pins.digitalWritePin(DigitalPin.P1,
  0)
  basic.pause(500)
})
```

Lesson4. Motor Control

DC motor is a very common component in DIY, this lesson will teach you control the motor rotation. As we know, the motor need a large current to drive itself, so we need a mosfet to control the motor run and stop. Connect the Crowtail- MOSFET to P1 interface and connect the DC motor to the output terminal of the MOSFET. Upload the code, when press button A, the motor start run, when press button B, the motor stop run.

Elecrow on-line store, make your making easier.

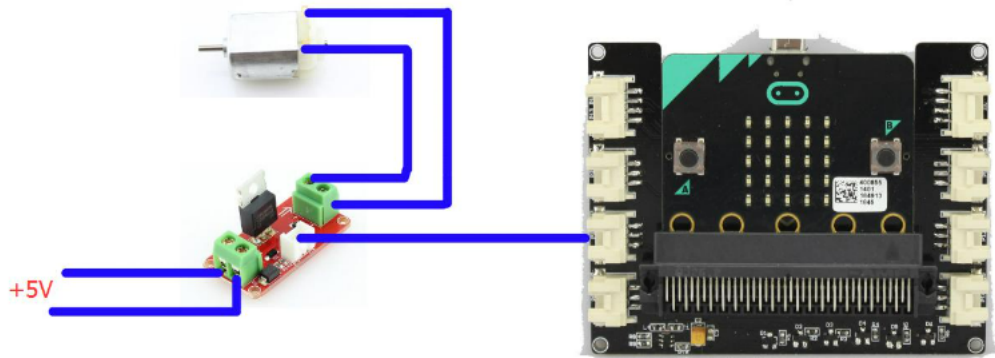

Material:

- Micro:bit x1
- Crowtail- Base Shield for Micro:bit x1
- Crowtail- MOSFET x1
- DC Motor x1

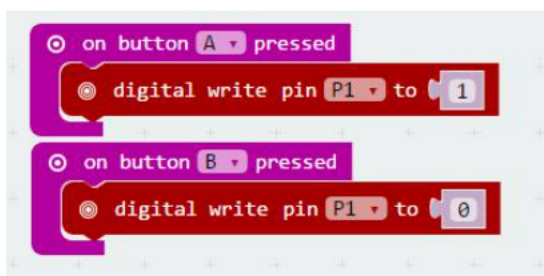

```
input.onButtonPressed(Button.A, () => {
  pins.digitalWritePin(DigitalPin.P1, 1)
})
input.onButtonPressed(Button.B, () => {
  pins.digitalWritePin(DigitalPin.P1, 0)
})
```

Lesson5.Motion Detection

This lesson teach you use the PIR Motion sensor to detect movement, then with other parts can do many interest application. Connect the Crowtail- PIR sensor to P2 interface, and connect one LED to P1 interface, then upload the code, when a person or other animals move close to this motion sensor the LED will light on 1 second.

Elecrow on-line store, make your making easier.

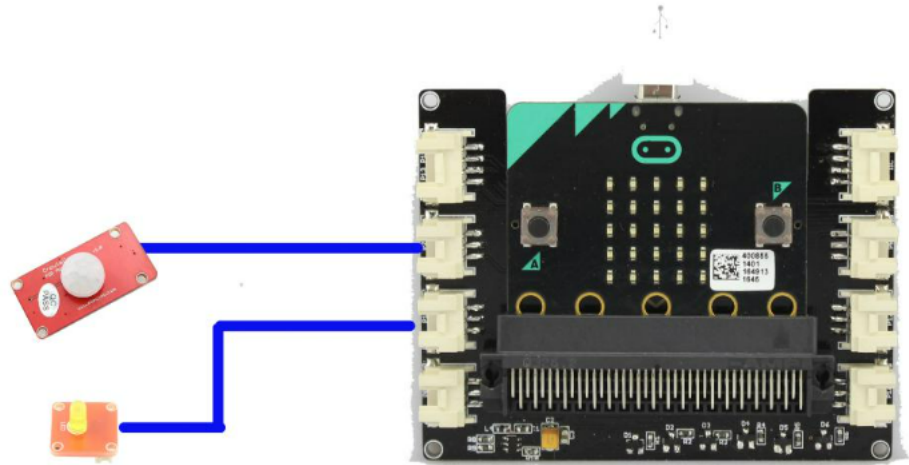

Material:

Micro:bit x1
Crowtail- Base Shield for Micro:bit x1
Crowtail- PIR Motion Sensor x1
Crowtail- LED x1

```
basic.forever(() => {  
  pins.digitalWritePin(DigitalPin.P1, pins.digitalReadPin(DigitalPin.P2))  
  basic.pause(1000)  
})
```

Lesson6. Relay ON/OFF

The relay has used in may place in our daily life, so we must to know how to use it. Connect the Crowtail- Relay to P1 interface,then upload the code into Micro:bit, you will hear a mechanical on/off sound from the relay every 2 seconds, if you connect some other high voltage device to the output terminal of the relay, then we can control this device on/off.

<https://www.elecrow.com/>

Elecrow on-line store, make your making easier.

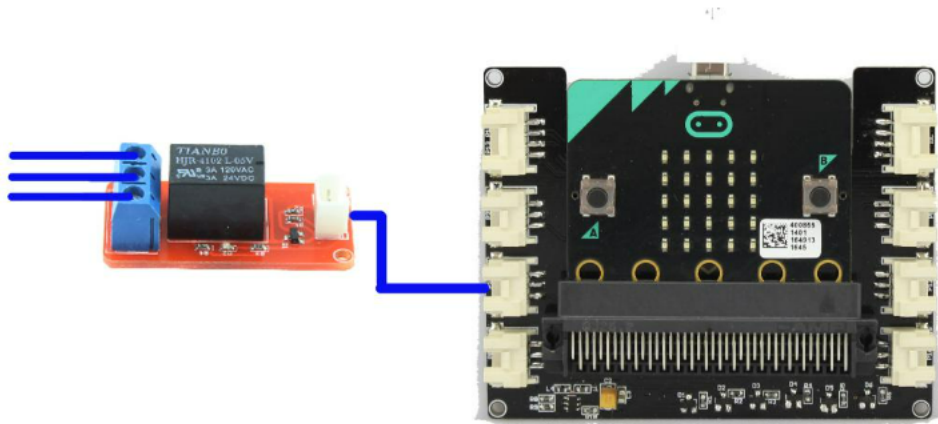

Material:

Micro:bit	x1
Crowtail- Base Shield for Micro:bit	x1
Crowtail- Relay	x1

```
on start
forever
  digital write pin P1 to 1
  pause (ms) 2000
  digital write pin P1 to 0
  pause (ms) 2000
```

```
basic.forever(() => {
  pins.digitalWritePin(DigitalPin.P1, 1)
  basic.pause(2000)
  pins.digitalWritePin(DigitalPin.P1, 0)
  basic.pause(2000)
})
```

Lesson7.Soil Moisture Detection

We like to raise some soil plants, but not know when and how much to watering the plants, so this lesson will teach you detect the soil moisture. Connect the Crowtail- Moisture sensor to P0 interface, then upload the code into micro:bit, you will view the analog value of the soil moisture of the soil on the LED dot matrix.

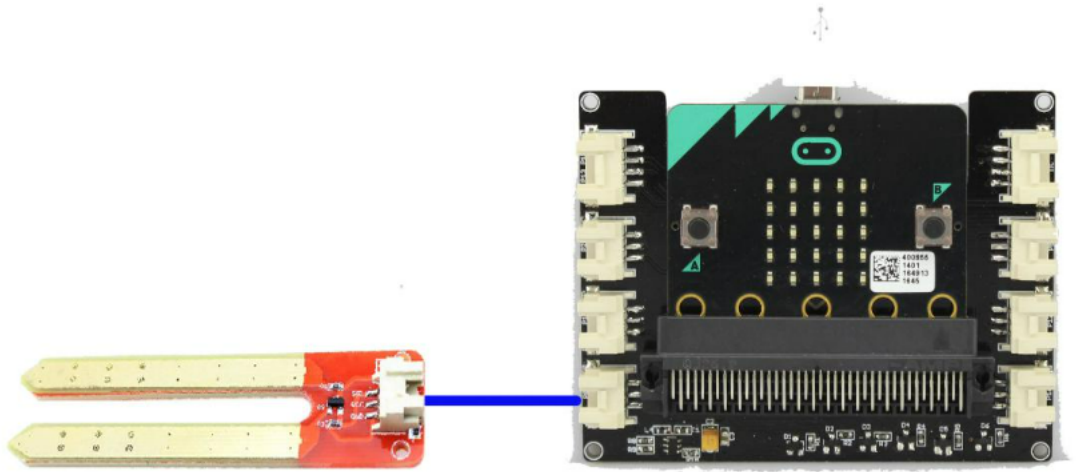

Material:

- Micro:bit x1
- Crowtail- Base Shield for Micro:bit x1
- Crowtail- Moisture sensor x1



```
let reading = 0
basic.forever(() => {
  reading = pins.analogReadPin(AnalogPin.P0)
  led.plotBarGraph(
    reading,
    1023
  )
  if (input.buttonIsPressed(Button.A)) {
    basic.showNumber(reading)
  }
})
```

Lesson8.Sound Detection

In our daily life, some people like lively, some like quiet , if we use sound reasonably, it will play a huge role in the field of intelligence, this lesson will teach you detect the sound as a switch to power on one LED. Connect the Crowtail- Sound sensor to P1 interface and connect one LED to P2 interface, upload the code, if the sound sensor detect some sound , the LED will light on 2 seconds.

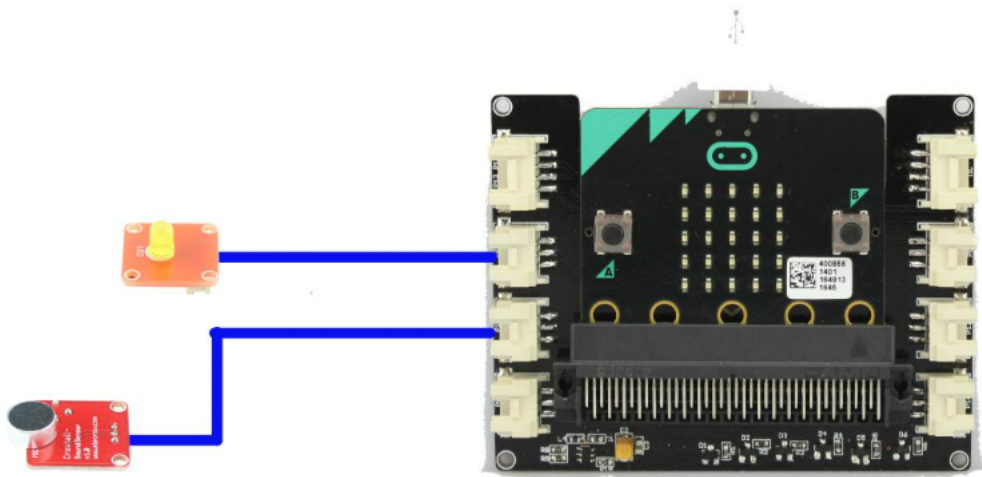

Material:

- Micro:bit x1
- Crowtail- Base Shield for Micro:bit x1
- Crowtail- Sound sensor x1
- Crowtail- LED x1

```
let reading = 0
basic.forever(() => {
  reading =
  pins.digitalReadPin(DigitalPin.P0)
  if (reading) {
    pins.digitalWritePin(DigitalPin.P2, 1)
    basic.pause(2000)
    pins.digitalWritePin(DigitalPin.P2, 0)
  }
})
```

Lesson9.Breathing LED

Control the LED with different frequency PWM wave, in the lesson we use a loner potentiometer to adjust the PWM frequency, the LED will light brighter and brighter,then light darker and darker, which is like breathing . Connect the crowtail- LED to P0 interface and connect the crowtail- liner potentiometer to P1 interface, upload the code into micro:bit, then slide the line potentiometer and observe the LED.

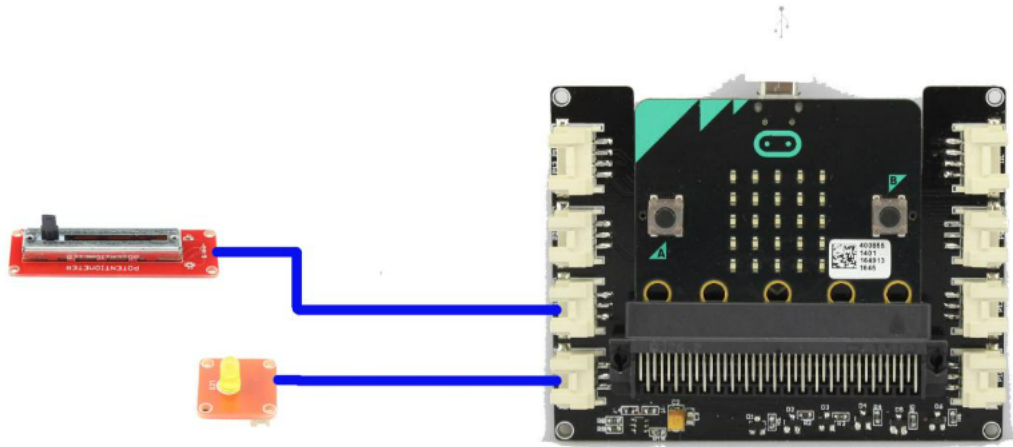

Material:

- Micro:bit x1
- Crowtail- Base Shield for Micro:bit x1
- Crowtail- LED x1
- Crowtail- Linear Potentiometer x1

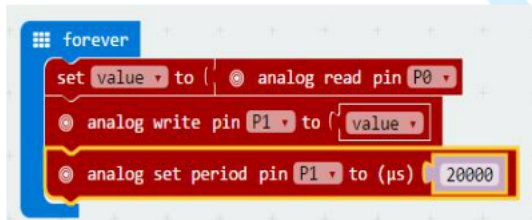

```
let value = 0
basic.forever(() => {
  value =
  pins.analogReadPin(AnalogPin.P0)
  pins.analogWritePin(AnalogPin.P1,
  value)
  pins.analogSetPeriod(AnalogPin.P1,
  20000)
})
```

Lesson10.Servo Calibrator

In this Lesson, will teach you how to use buttons to control the servo with different rotating angle, and you can view the current angle from the LED dot matrix. Connect the Crowtail- Servo to P0 interface, then upload the code into micro:bit, press the button A, after seconds press button B, view the servo rotated and read the current angle.

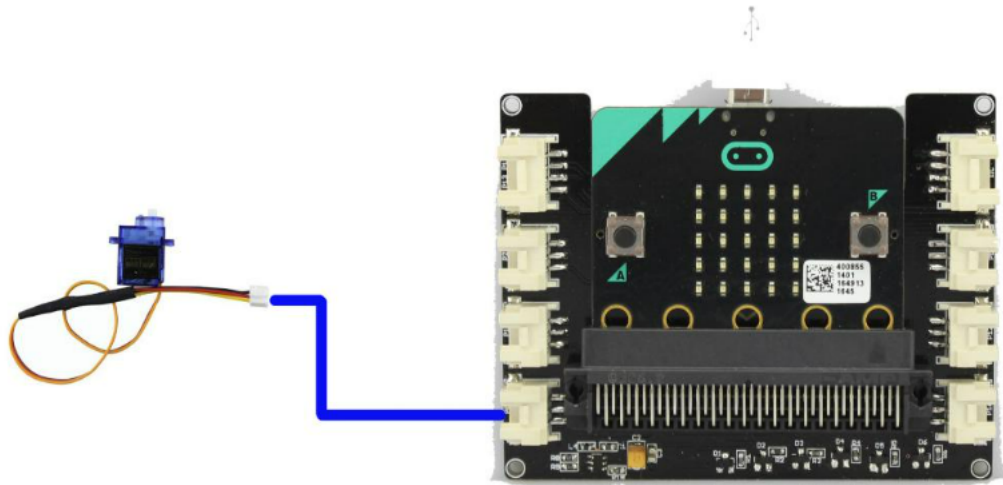

Material:

- Micro:bit x1
- Crowtail- Base Shield for Micro:bit x1
- Crowtail- 9G Servo x1

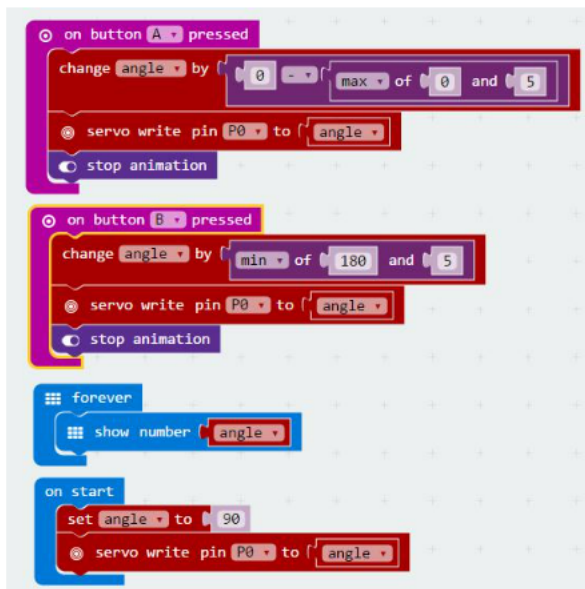

```
let angle = 0
input.onButtonPressed(Button.A, () => {
  angle += 0 - Math.max(0, 5)
  pins.servoWritePin(AnalogPin.P0, angle)
  led.stopAnimation()
})
input.onButtonPressed(Button.B, () => {
  angle += Math.min(180, 5)
  pins.servoWritePin(AnalogPin.P0, angle)
  led.stopAnimation()
})
angle = 90
pins.servoWritePin(AnalogPin.P0, angle)
basic.forever(() => {
  basic.showNumber(angle)
})
```

Lesson11.Magnetic Field Detection

This lesson will teach you detect the magnetic filed , we use a magnet simulate the magnetic field, when the magnetic sensor close to the magnet, it will have response and the LED will light on. Connect the Crowtail- Magenet switch to P0 interface and connect the crowtail - LED to P1 interface.

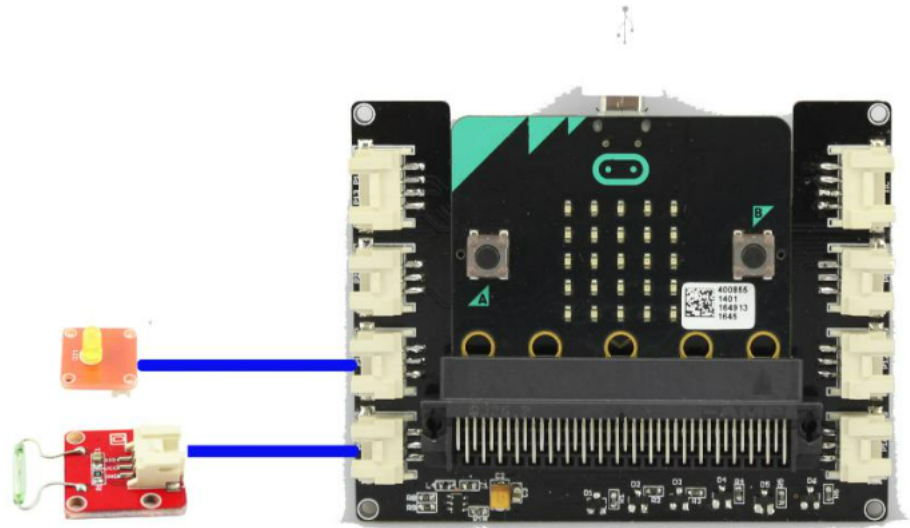

Material:

- Micro:bit x1
- Crowtail- Base Shield for Micro:bit x1
- Crowtail- Magenet switch x1
- Crowtail- LED x1

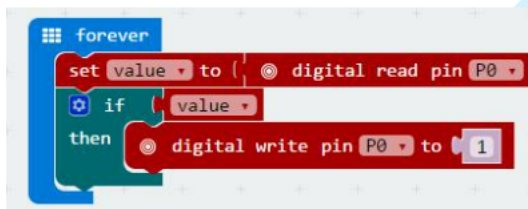

```
let value = 0
basic.forever(() => {
  value = pins.digitalReadPin(DigitalPin.P0)
  if (value) {
    pins.digitalWritePin(DigitalPin.P0, 1)
  }
})
```

Lesson12.Control the MOSFET as a Switch

As MOSFET has a high speed response and high stability, we usually use it as a switch in some application, this lesson will teach you how to control the MOSFET on/off. Connect the crowtail-MOSFET to P0 interface and connect one LED to the output terminal of the MOSFET, then upload the code into micro:bit, you will see the LED blink.

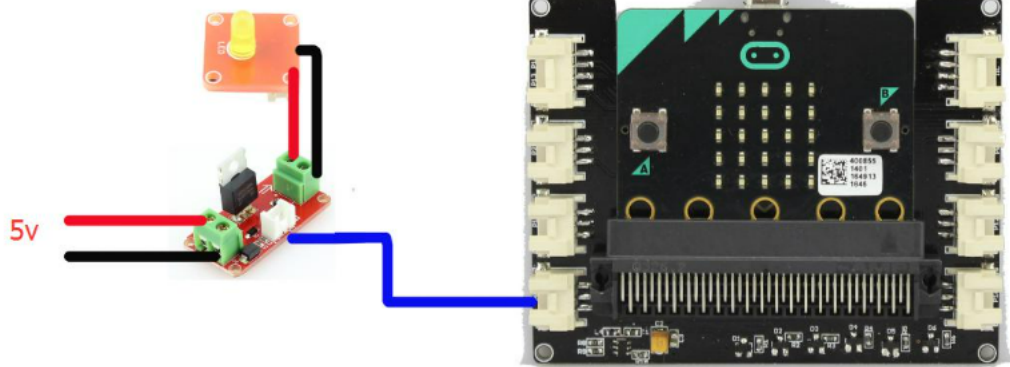

Material:

- Micro:bit x1
- Crowtail- Base Shield for Micro:bit x1
- Crowtail- MOSFET x1
- LED x1

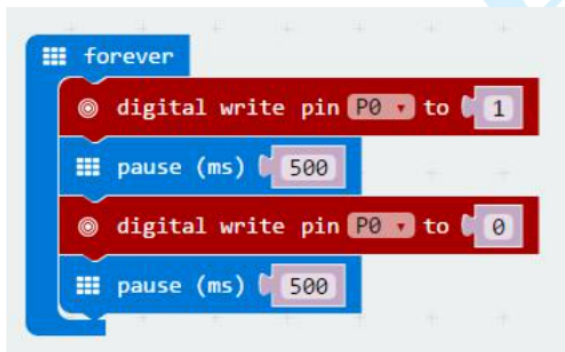

```
basic.forever(() => {  
  pins.digitalWritePin(DigitalPin.P0, 1)  
  basic.pause(500)  
  pins.digitalWritePin(DigitalPin.P0, 0)  
  basic.pause(500)  
})
```

Lesson13.Obstacle Detection

Smart car is the most common application in DIY, obstacle avoidance is the basic function, this lesson will teach you how to use IR reflective sensor to detect obstacle. Connect the Crowtail IR reflective sensor to P0 interface and connect the crowtail- buzzer to P1 interface. Upload the code , when the sensor detect the obstacle, the buzzer will make a noise.

Note: The detection distance is 4-15 mm.

Elecrow on-line store, make your making easier.

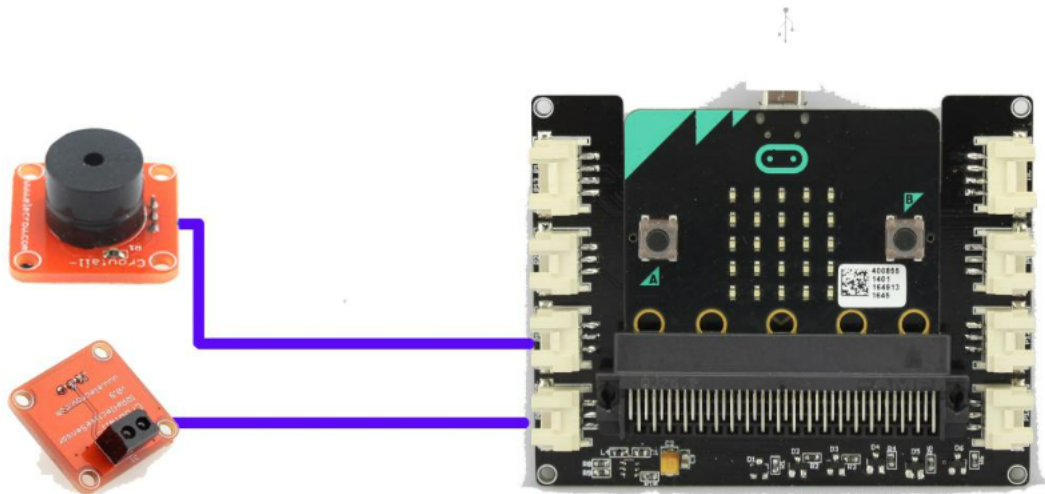

Material:

- Micro:bit x1
- Crowtail- Base Shield for Micro:bit x1
- Crowtail- IR Reflective Sensor x1
- Crowtail- Buzzer x1

```
on start
  forever
    set value to ( digital read pin P0 )
    if value
      then digital write pin P1 to 1
    else digital write pin P1 to 0
```

```
let value = 0
basic.forever(() => {
  value =
  pins.digitalReadPin(DigitalPin.P0)
  if (value) {
    pins.digitalWritePin(DigitalPin.P1, 1)
  } else {
    pins.digitalWritePin(DigitalPin.P1, 0)
  }
})
```

Lesson14. IR Distance Measurement

If we can make some tools that can measure the distance , it sounds very interesting .This Lesson will teach you use IR to detect short distance. Connect the Crowtail- 80cm Infrared Proximity Sensor to P0 interface, then upload code, aim the probe at the front object, you will view the distance between the probe and the object, which show on the LED dot matrix.

Note: Distance measuring range: 10 cm to 80 cm

Elecrow on-line store, make your making easier.

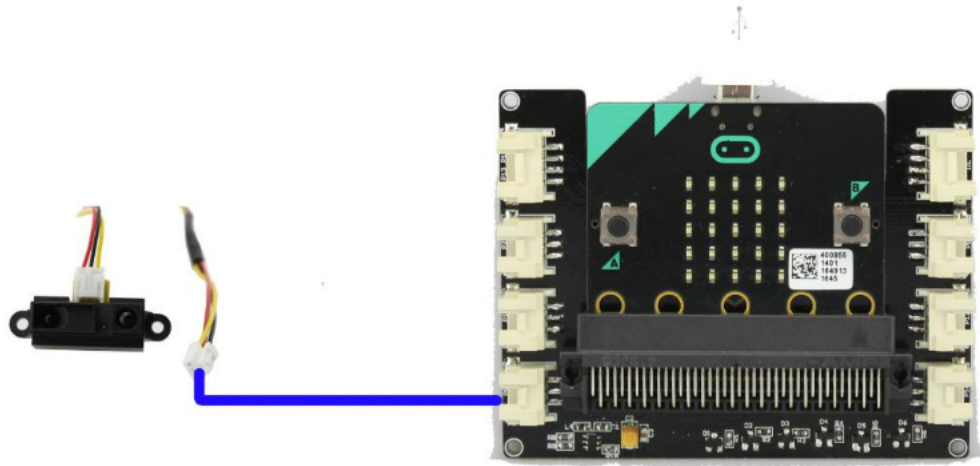

Material:

- Micro:bit x1
- Crowtail- Base Shield for Micro:bit x1
- Crowtail- 80cm Infrared Proximity Sensor x1

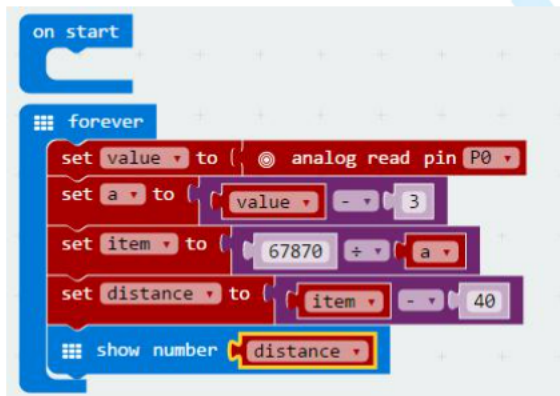

```
let distance = 0
let item = 0
let a = 0
let value = 0
basic.forever(() => {
value = pins.analogReadPin(AnalogPin.P0)
a = value - 3
item = 67870 / a
distance = item - 40
basic.showNumber(distance)
})
```

Lesson15.Use Microwave Detect Movement

Because of Microwave with strong penetration, fast response characteristics, so we usually use it in some exploration field. Connect the crowtail- microwave sensor to P1 interface, then upload the code, put the sensor in a quiet area, if there is activity issue within a radius of 15m, the LED on the sensor will blink. It means the sensor detect some movement.

Elecrow on-line store, make your making easier.

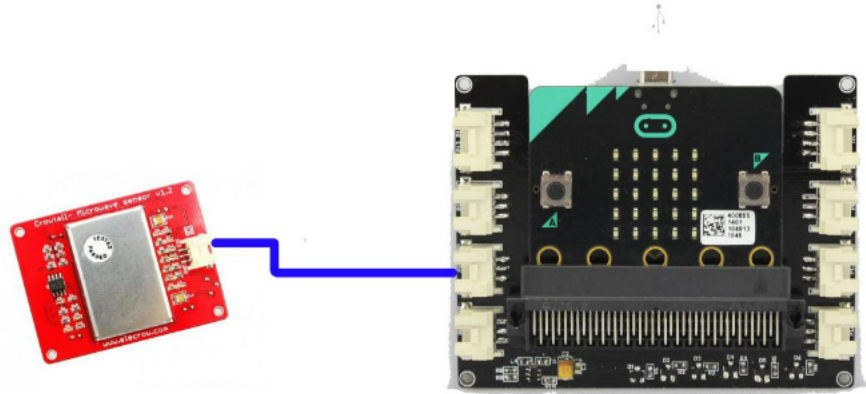

Material:

- Micro:bit x1
- Crowtail- Base Shield for Micro:bit x1
- Crowtail- Microwave sensor x1



```
let item = 0
basic.forever(() => {
  item =
  pins.digitalReadPin(DigitalPin.P1)
})
```

Lesson16.Stairs Lights

In order to save power energy, the stair light not need light all the time, only when there are poor light and the pace of someone's footsteps, then the light will on. Connect the crowtail- light sensor to P0 interface , connect the crowtail- sound sensor to P1 interface and connect the crowtail- LED to P2 interface, after upload the code , if detect some noise or the the Brightness is dark, the LED will light.

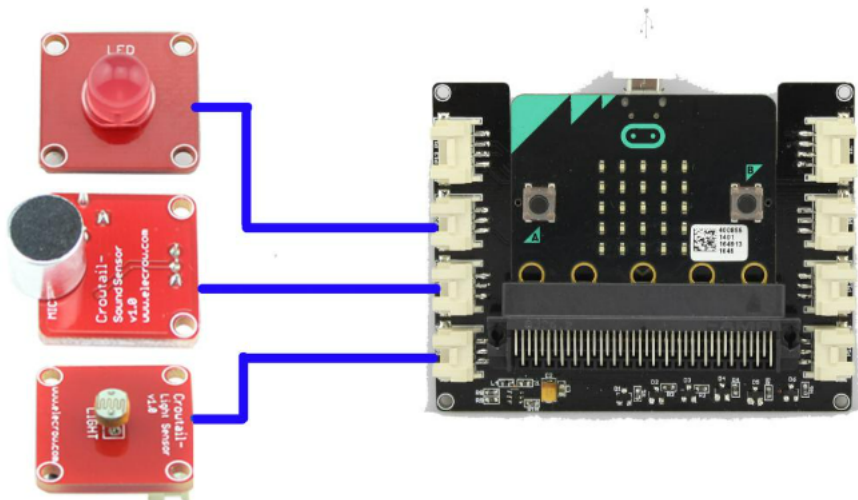

Material:

- Micro:bit x1
- Crowtail- Base Shield for Micro:bit x1
- Crowtail- Sound Sensor x1
- Crowtail- LED x1
- Crowtail- Light Sensor x1

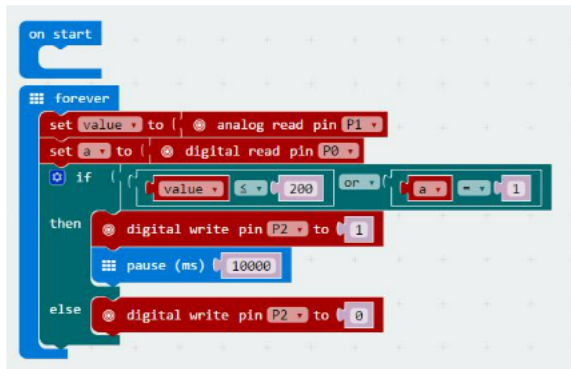

```
let a = 0
let value = 0
basic.forever(() => {
  value =
  pins.analogReadPin(AnalogPin.P1)
  a =
  pins.digitalReadPin(DigitalPin.P0)
  if (value <= 200 || a == 1) {
    pins.digitalWritePin(DigitalPin.P2
, 1)
    basic.pause(10000)
  } else {
    pins.digitalWritePin(DigitalPin.P2
, 0)
  }
})
```

Lesson17.Alarm Clock

Let us use the micro:bit to make an alarm clock, first connect the Crowtail -RTC to the IIC interface to get the real time, then set the alarm clock rang time, when the time is up, the crowtail- Buzzer will sound. Connect the Crowtail- RTC to P0 interface, connect the crowtail- Buzzer to P1 interface.

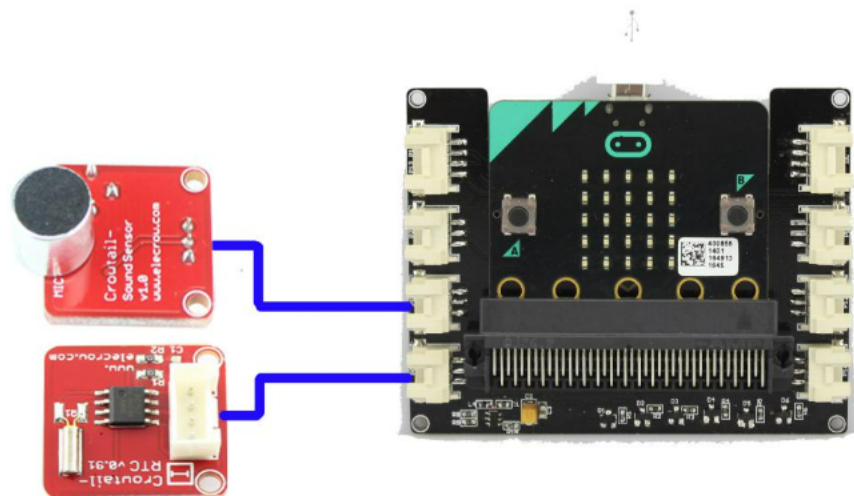

Elecrow on-line store, make your making easier.

Material:

- Micro:bit x1
- Crowtail- Base Shield for Micro:bit x1
- Crowtail- RTC x1
- Crowtail- Buzzer x1

First, you should add the package: <https://github.com/robotfreak/pxt-ds1307>

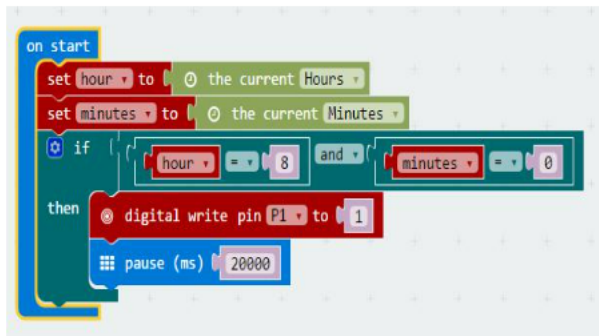

```
let minutes = 0
let hour = 0
hour =
Time.getTimePart(DateTimePart.Hours)
minutes =
Time.getTimePart(DateTimePart.Minutes)
if (hour == 8 && minutes == 0) {
pins.digitalWritePin(DigitalPin.P1, 1)
basic.pause(20000)
}
```

Lesson18.Anti-theft Device

We also see some infrared security in the movie, in this lesson will teach you use microwave to built a Anti-theft device, if someone enter the detection area, the alarm will sound. Connect the Crowtail- Microwave Sensor to P1 interface, connect the Crowtail- Buzzer to P0 interface.

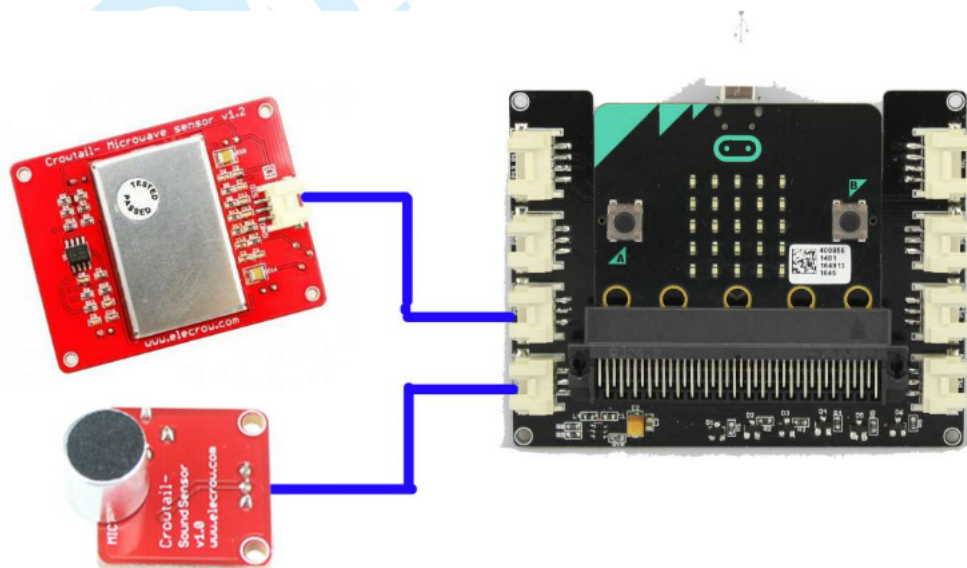

Material:

- Micro:bit x1
- Crowtail- Base Shield for Micro:bit x1

<https://www.elecrow.com/>

Crowtail- Microwave Sensor x1

Crowtail- Buzzer x1

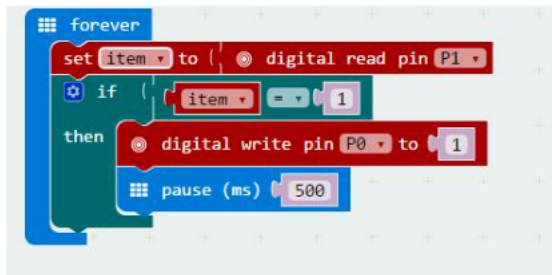

```
let item = 0
basic.forever(() => {
  item =
  pins.digitalReadPin(DigitalPin.P
  1)
  if (item == 1) {
    pins.digitalWritePin(DigitalPin.
    P0, 1)
    basic.pause(500)
  }
})
```

Lesson19.Mini Fan

When a hot day outside, if there is a mini Fan near you, maybe it is a enjoyable things, this lesson will teach you how to use use micro:bit built a mini Fan, we can use a button to control the relay to switch the Fan on or off. Connect the Crowtail- Switch to P0 interface, connect the Crowtail- Relay to P1 interface, connect the Fan to the other side of the Relay.

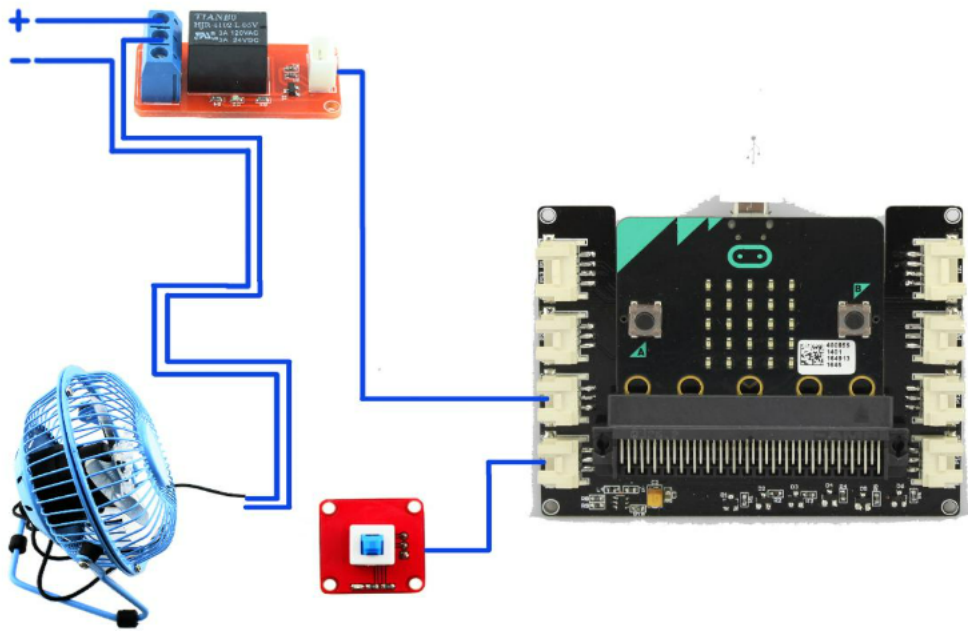

Material:

Micro:bit x1

Crowtail- Base Shield for Micro:bit x1

Crowtail- Switch x1

Crowtail - Relay x1

Mini Fan x1 This 5 V Fan not provide by us.

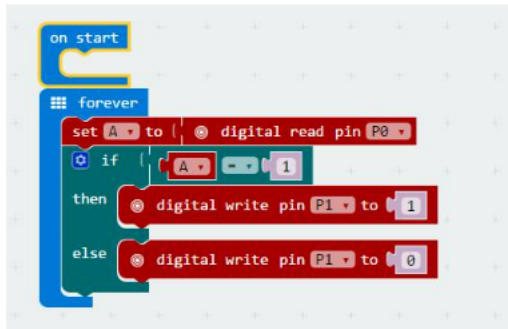

```
let A = 0
basic.forever(() => {
  A = pins.digitalReadPin(DigitalPin.P0)
  if (A == 1) {
    pins.digitalWritePin(DigitalPin.P1, 1)
  } else {
    pins.digitalWritePin(DigitalPin.P1, 0)
  }
})
```

Lesson20. Automatic Watering

Beautiful flowers, green plants are what we love, but they are difficult to cultivate, we usually forget to water them. This lesson will teach you built a automatic Watering system, it will water the flower or plants which base on its moisture. Connect the Crowtail- Moisture Sensor to P0 interface , connect the Crowtail- Relay to P1 interface and connect the pump to another side of the Relay. And use two pipe connect the water in and water out of the pump.

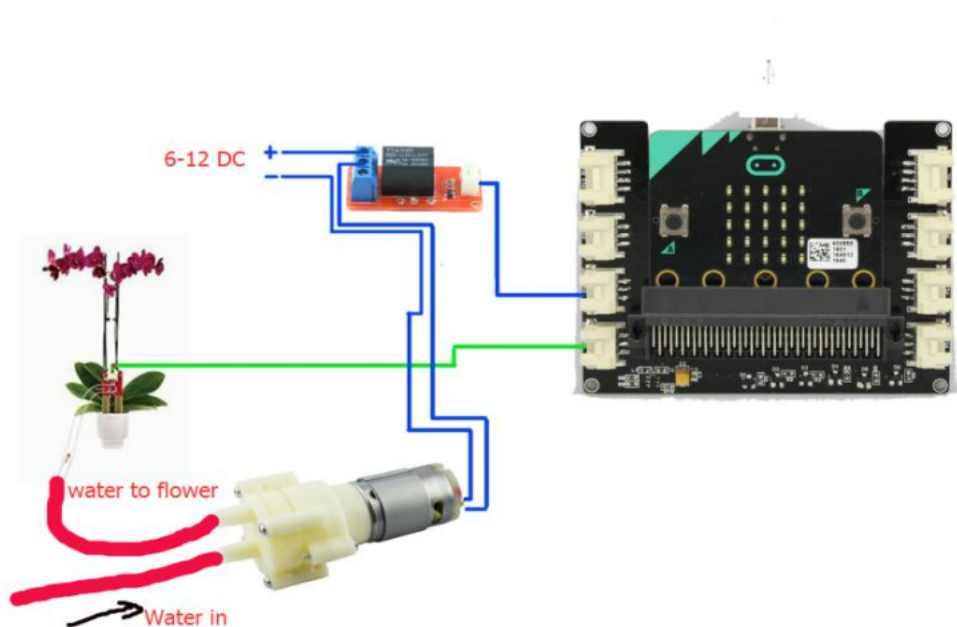

Material:

- Micro:bit x1
- Crowtail- Base Shield for Micro:bit x1
- Crowtail- Switch x1
- Crowtail - Relay x1
- Crowtail- Moisture Sensor x1
- Pump x1
- 3mm pipe for pump x2

Elecrow on-line store, make your making easier.

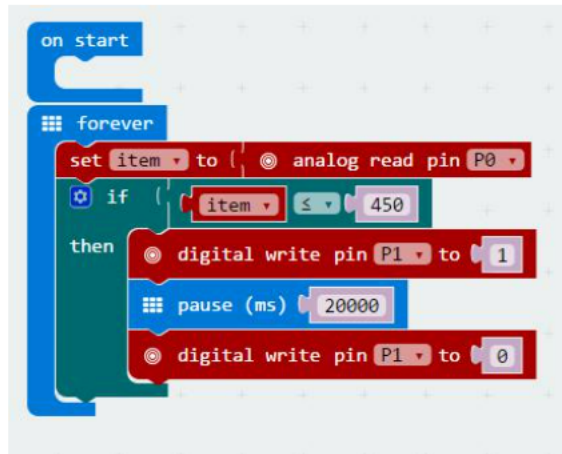

```
let item = 0
basic.forever(() => {
  item =
  pins.analogReadPin(AnalogPin.P0)
  if (item <= 450) {
    pins.digitalWritePin(DigitalPin.P1,
    1)
    basic.pause(20000)
    pins.digitalWritePin(DigitalPin.P1,
    0)
  }
})
```



Elecrow on-line store, make your making easier.



<https://www.elecrow.com/>