







KNIPPERLED

Tijdens deze opdracht ga je:

- een breadboard met led aansluiten op je Micro:Bit
- een led automatisch aan- en uitzetten
- een Micro:Bit programmeren

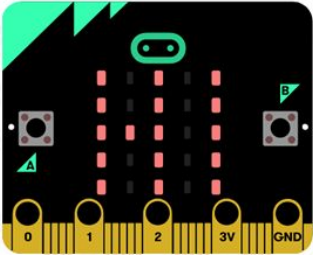
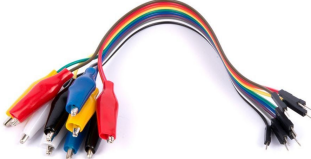
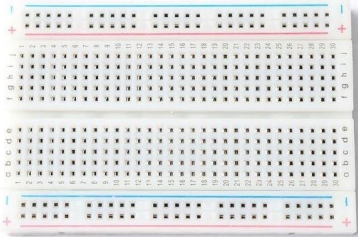
Benodigheden:

| | |
|---|---|
| <p>- iPad => Micro:Bit app</p>  | <p>- led</p>  |
| <p>- Micro:Bit</p>  | <p>- 2x krokodillenklemmetje naar male jumper wire</p>  |
| <p>- breadboard</p>  | <p>- weerstand (1 x 220 Ω)</p>  <p>- jumper wires (male to male)</p>  |

Programmacode:

```

de hele tijd
schrijf digitaal pin P1 naar 1
pauzeer (ms) 500
schrijf digitaal pin P1 naar 0
pauzeer (ms) 500

```



Breadboard lay-out:

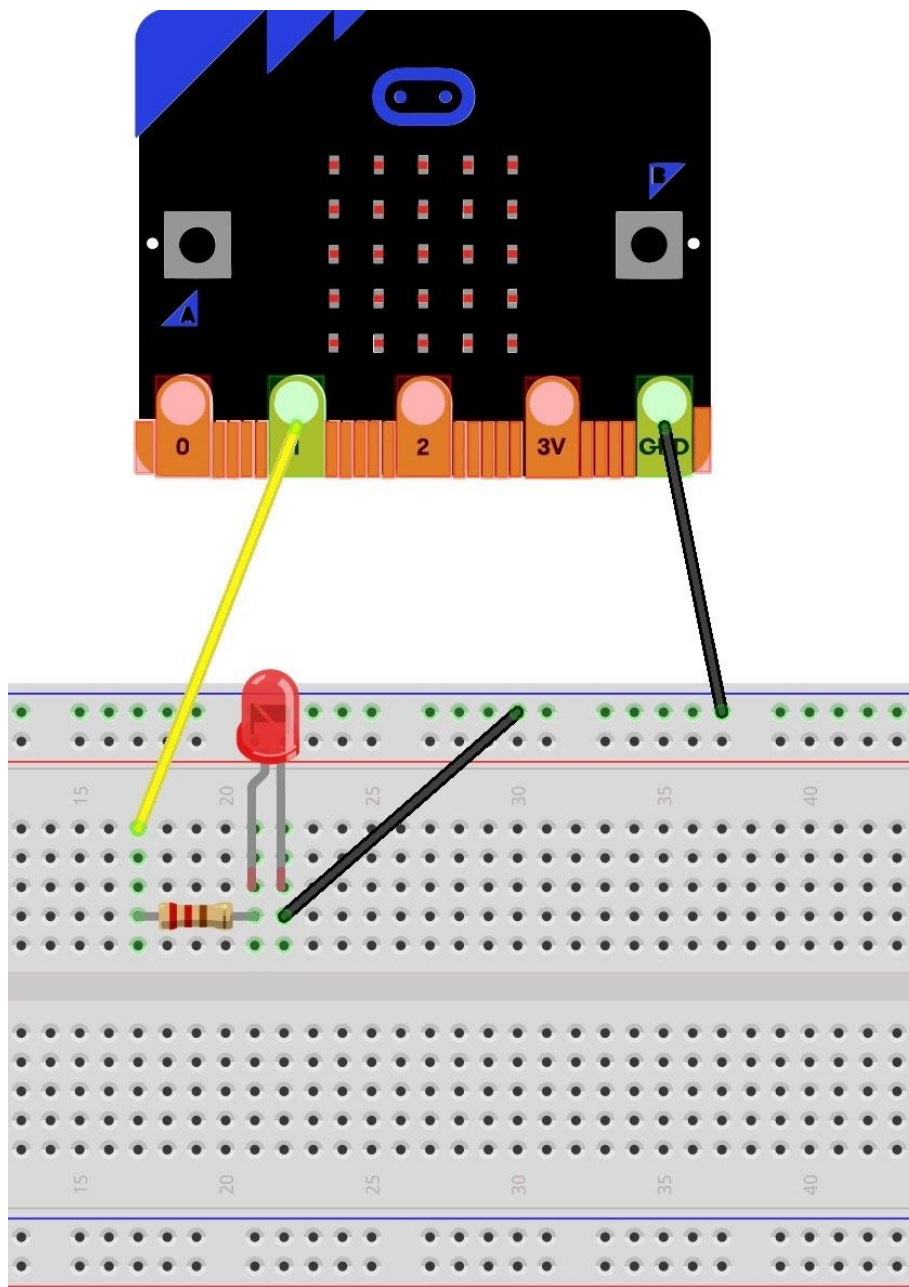

Uitbreiding:

- 1) Verander de tijd van het knipperen.
- 2) Laat het knipperen versnellen.
- 3) Laat het knipperen vertragen.
- 4) Schakel meerdere led's parallel op je breadboard.